



USER MANUAL

Lifting hook for drums



We hereby declare that the user manual is according with the Machinery Directive 2006/42/EF.



Lifting accessory, not connected to the lifting machine, destined to become an integral part of the load.

D.Lgs n. 17 27/01/2010, Suppl. Ord. GU n. 41 19/02/2010, Art. 1, accomplishment 2006/42/CE.



M46300000 – Capacity 2000Kg

M46400000 – Capacity 5000Kg

INSTRUCTIONS OF INSTALLATIONS, USE AND MAINTENANCE

ORIGINAL INSTRUCTIONS – 04/2018

In conformity to the original instruction manual in Italian language version 04/2018

SUMMARY

1. GENERAL DATA OF THE LIFTING DEVICE AND TECHNICAL DATA	6
1.1 INTRODUCTION	6
1.2 PRESENTATION.....	6
1.3 USE AND STORAGE OF THE USER AND MAINTENANCE MANUAL.....	8
1.4 REQUIRED SKILLS.....	9
1.5 INTENDED USE OF THE LIFTING DEVICE	9
1.5.1 DESTINATION	9
1.5.2 USERS OPERATORS OF LIFTING DEVICE	9
1.5.3 EXPECTED REGULATIONS.....	10
1.5.4 INTENDED USES AND NOT ALLOWED USES	10
1.5.5 PREVENTIVE MEASURES TO BE USED BY THE USER	10
1.5.6 CONDITIONS OF USE	10
2. SAFETY NORMS.....	11
2.1 GENERAL WARNINGS.....	11
2.2 ESSENTIAL SAFETY REQUIREMENTS.....	11
2.2.1 VIBRATIONS	11
2.2.2 SOUND EMISSIONS.....	12
2.2.3 ILLUMINATION	12
2.3 USE INCORRECTLY FORESEEABLE REASON	12
2.4 RESIDUAL RISKS.....	12
2.5 SIGNALING HAZARDS AND BANS	12
2.6 INDIVIDUAL PROTECTIONS (PPE)	13
2.7 CONTROLS AND CHECKS	13
3. TECHNICAL DESCRIPTION OF THE LIFTING DEVICE	15
3.1 CHARACTERISTICS	15
3.2 TECHNICAL DATA.....	16
4. INSTRUCTIONS FOR TRANSPORTING AND INSTALLING THE LIFTING DEVICE.....	16
4.1 HANDLING.....	16
4.1.1 STORAGE.....	16
4.2 INSTALLATION OF THE LIFTING DEVICE	17
4.2.1 PRELIMINAR CHECKS.....	17
4.2.2 FINAL CHECKS	17
4.2.3 CARDBOARD, P.P.E. AND TRAINING.....	17
5. ISTRUCTIONS FOR THE USE	18
5.1 PRELIMINARY ACTIONS	19
5.2 EQUIPMENT FOR THE LIFTING	19
5.3 USE OF THE LIFTING DEVICE	20
6. MAINTENANCE	21
6.1 PERIODIC OPERATIONS.....	21

DATA OF THE MANUFACTURER

Manufacturer:

VOLTA MACCHINE SRL
Via Copernico 13A
39100 Bolzano - ITALIA Tel. :
0471 546100
Fax. : 0471 546199
E-MAIL: info@volta-macchine.com

GENERAL NOTES TO THE DELIVERY

Upon receiving the lifting device, the receiver must check that the supply is complete and in compliance with the order (the lifting device must have all the safety devices in operation and must be accompanied by the user and maintenance manual), that the parts are not damaged, in which case they must be immediately reported to **VOLTA MACCHINE SRL** in written and documented form, referring to the specific data of the lifting device.

GENERAL WARRANTY CONDITIONS

- a) The lifting device supplied is guaranteed for a period of 12 months, starting from the delivery date.
- b) The warranty is valid only if the lifting device cannot work due to defects of materials, workmanship or due to an important construction fault. These defects must be communicated immediately to **VOLTA MACCHINE SRL** in writing, in the most detailed way possible.
- c) The warranty commits our company to the free replacement, at our factory in Bolzano, of components recognized as faulty manufacturing and / or related technical performance.
- d) The warranty become null if the lifting device has been tampered with, modified or repaired by our office.
- e) Our company is not liable for any direct or indirect damage caused by negligence, mistaken or improper use and installation, and in any case by phenomena not related to the normal operation of the lifting device, as well as bruises during transport.
- f) For any dispute, the place of jurisdiction is Bolzano.

In case of intervention of **VOLTA MACCHINE SRL** out of the warranty conditions mentioned above, the lifting device must be delivered, at the expense and risk of the purchaser, to our headquarters in Bolzano. For the intervention at the customer's home, the travel and stay expenses of our technical staff will be charged. For each day of stay of such staff will be charged a daily fee to be agreed at the time of the request for intervention.

VOLTA MACCHINE SRL Via Copernico, 13 A 39100 Bolzano - ITALIA	DEVICE FOR AXIAL LIFTING OF DRUMS MODELS: M46300000 M46400000	 FYNS KRAN UDSTYR A/S
--	--	---

VOLTA MACCHINE SRL

Via Copernico, 13 A
39100 Bolzano – ITALIA
Tel. 0471 546100 – Fax 0471 546199
Email: info@volta-macchine.com

All rights of reproduction of this manual are reserved to VOLTA MACCHINE SRL. The descriptions and illustrations provided in the following publication are not binding. VOLTA MACCHINE SRL reserves the right to make changes at any time that it deems appropriate. This manual cannot be transferred to third parties without the written permission of VOLTA MACCHINE SRL.

REPRODUCTION IS STRICTLY FORBIDDEN, EVEN PARTIAL,
OF THE ILLUSTRATIONS AND/OR TEXT

⚠ WARNING

IMPORTANT WARNING

This manual is to be considered an integral part of the supply of the lifting device; if it is damaged or illegible in any part, a copy must be requested immediately.

Before using the lifting device, the site manager and the operator are obliged to read the instruction manual.

The information contained in it is addressed to all operators in charge of carrying out and / or maintaining the lifting device. The operating and maintenance instructions contain important information on the safe, compliant and economical use of the lifting device. Their observance helps to avoid hazards, reduce repair and downtime costs and increase the lifespan of the lifting device.

The instructions for use and maintenance must always be available at the place where the lifting device is used.

VOLTA MACCHINE SRL Via Copernico, 13 A 39100 Bolzano - ITALIA	DEVICE FOR AXIAL LIFTING OF DRUMS MODELS: M46300000 M46400000	 FYN S K RAN UDSTYR A/S
--	--	---

CONFORMITY DECLARATION

	CE CONFORMITY DECLARATION	
---	------------------------------	---

1. MANUFACTURER NAME AND ADDRESS:

VOLTA MACCHINE S.r.l.
Via Copernico, 13/A
I-39100 Bolzano (BZ) ITALY

2. NAME AND ADDRESS OF THE PERSON AUTHORIZED TO MANAGE THE TECHNICAL DOSSIER:

Name and family name:
Address: Via Copernico, 13/A 39100 Bolzano (BZ) ITALY

3. DESCRIPTION OF THE MACHINE:

GENERIC DESCRIPTION:	LIFTING DEVICE	
FUNCTION:	LIFTING HOOK	
MODEL/TYPE:	<input checked="" type="checkbox"/> M46300000	<input type="checkbox"/> M46400000
SERIAL NUMBER:	19- 02991/1/2/3/4/5/6/7/8/9/10/11/12/13/14/15/16/17/18/19/20	
DIMENSIONS (height x width):	635x270	790x305
WEIGHT:	8,5 Kg	18 Kg
MAX. CAPACITY:	2000 Kg	5000 Kg
YEAR OF CONSTRUCTION:	2019	

4. DECLARATION OF THE MANUFACTURER:

The over mentioned manufacturer declares that the machine as it is identified, is comply to the requirements of the following directives applied:

CE directives applied:		
2006/42/CE – Machinery Directive		
Voluntary certificate issued by ISET S.r.l.	n° ISET V0142	n° ISET V0141

5. HARMONIZED NORMS APPLIED:

Harmonized norms applied:
EN ISO 12100-1:2003, Safety of machinery - Basic concepts, general principles for design - Part 1: Basic terminology, methodology
EN ISO 12100-2:2003, Safety of machinery -Basic concepts, general principles for design – Part 2: Technical principle
EN 13155:2003+A2:2009, Cranes - Safety - Non-fixed load lifting attachments

6. IDENTIFICATION OF THE SIGNER:

Name and family name: Othmar Pobitzer
Position: Legal Representative
Place and date: Bolzano, 21.05.2019

SIGN:



VOLTA MACCHINE SRL Via Copernico, 13 A 39100 Bolzano - ITALIA	DEVICE FOR AXIAL LIFTING OF DRUMS MODELS: M46300000 M46400000	 FYNS KRAN UDSTYR A/S
--	--	---

1. GENERAL DATA OF THE LIFTING DEVICE AND TECHNICAL DATA

1. INTRODUCTION

The safe use and maintenance of the lifting device covered by this Operation and Maintenance Manual are essential to avoid situations of risk, both for operators and for others, both in the operational and maintenance phases. In this regard it is essential that this document be read carefully and observed in the warnings contained therein.

IMPORTANT
Store and consult this manual

WARNINGS FOR THE OPERATOR

- Before using the lifting device, read the present manual carefully
- The operator must be instructed and trained in the use of the lifting device
- The operator must scrupulously observe all the instructions, safety rules and limits of use of the lifting device

ASSISTANCE SERVICE: before any particular repair, it is advisable to contact **VOLTA MACCHINE SRL**, in particular in cases of extraordinary assistance.

SPARE PARTS SERVICE: only original spare parts must be used for the maintenance of the lifting device, for this purpose contact **VOLTA MACCHINE SRL**.

1.2 PRESENTATION

IDENTIFICATION

The lifting device is identified with a 70x60 size plate which shows the main characteristics, among which:

- Manufacturer
- Year of construction
- Model
- Capacity
- Weight
- Admitted hole of the drum
- Serial number

In case of intervention or request information, notify the manufacturer of the data on this plate, in order to identify the exact model.

Do not remove, damage or modify the identification plate for any reason. Position the CE plate as shown in the figure on page 7.

VOLTA MACCHINE SRL
Via Copernico, 13 A
39100 Bolzano - ITALIA

**DEVICE FOR AXIAL LIFTING
OF DRUMS**
MODELS: M46300000
M46400000



FYNS KRAN UDSTYR A/S

CE

VOLTA[®]MACCHINE
Volta Macchine Srl
Via Copernico 13 A
I – 39100 Bolzano
Tel. +39 0471 546100

DRUM LIFTING HOOK
Model: **M46300000**
Serial number:
Weight: 8,5 kg
Year of production: 2017

MAX. CAPACITY : 2000 kg
DRUM HOLE Min / Max : 60 mm / 140 mm

CE

VOLTA[®]MACCHINE
Volta Macchine Srl
Via Copernico 13 A
I – 39100 Bolzano
Tel. +39 0471 546100

DRUM LIFTING HOOK
Model: **M46400000**
Serial number:
Weight: 18 kg
Year of production: 2017

MAX. CAPACITY : 5000 kg
DRUM HOLE Min / Max : 90 mm / 160 mm

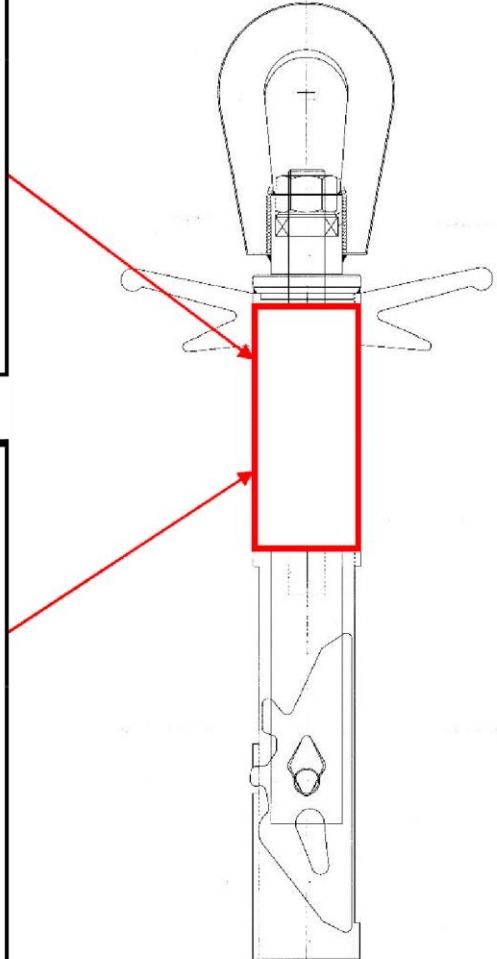

Lifting device compliant with CE marking. The lifting device does not fall within the domain of Annex IV of the Machinery Directive because it is not included among those listed.

VOLTA MACCHINE SRL Via Copernico, 13 A 39100 Bolzano - ITALIA	DEVICE FOR AXIAL LIFTING OF DRUMS MODELS: M46300000 M46400000	 FYNS KRAN UDSTYR A/S
--	--	---

1.3 USE AND STORAGE OF THE USER AND MAINTENANCE MANUAL

PICTOGRAMS USED:

Here below is an explanation of the symbols (pictograms) relating to safety in use, used in this manual:

DANGER

It refers to a dangerous situation which, if not avoided, will be a certain cause of irreversible damage.

WARNING

It refers to a dangerous situation which, if not avoided, could cause serious damages.

ATTENTION

It refers to a dangerous situation that, if not avoided, exposes you to the risk of injury or damages.

NOTE

It refers to useful and necessary information to highlight.

MANUAL RECIPIENTS:

the operators that succeed each other during the use of the lifting device, above all for the parts concerning the safety of the job.

MANUAL PURPOSE:

the information contained in the manual is necessary for the correct use of the lifting device, according to the intended design and construction purposes. The necessary information on the handling, commissioning and maintenance of the lifting device is also provided, all in compliance with the limits set by the manufacturer indicated in the manual.

MANUAL PRESERVATION:

the use and maintenance booklet is an integral part of the lifting device and must be kept, for its consultation, until its dismantling, even when it is handed over to another user. It must be kept in a protected and dry place. In case of damage, the user must request a copy from the manufacturer.

MANUAL UPDATE:

the manufacturer reserves the right to make changes to the lifting device, and consequently to the relative manuals, without the obligation to update the previous editions. The user can however ask for information about updates to the manufacturer. These updates, once released, become an integral part of the user and maintenance manual.

KNOWLEDGE OF THE MANUAL:

the site manager is obliged to make all the operators know the instructions contained in the manual. Before using the lifting device, it is essential that the operator is well acquainted with the positions and operation of the levers, and must also be able to perform all the operations described in this manual, making sure that the safety and know how to apply correctly during use and / or maintenance. The operator must be aware of the regulations concerning the prevention of accidents according to

Legislative Dlgs 81/08. The site manager is obliged to check the application of the instructions contained in the manual.

ATTENTION

The instruction manual is not a professional training manual, meaning that its knowledge does not replace the level of professionalism required for the operator.



CASES THAT LIFT THE MANUFACTURER FROM RESPONSIBILITY:

VOLTA MACCHINE SRL is relieved of all responsibility in the following cases:

- improper use of the lifting device or its use by untrained personnel for professional use unintended use
- tampering and / or changes made without your written consent
- use of non-original spare parts
- insufficient maintenance
- total or partial failure to comply with the instructions for use exceptional events.

⚠ ATTENTION

The lifting device must be used **ONLY** for the purpose for which it was designed

1.4 REQUIRED SKILLS

The lifting device must **ONLY** be used by skilled and competent operators: they must be trained to use the lifting device through a training course carried out by qualified personnel.

The maintenance operations must be carried out by a qualified mechanical maintenance technician, able to perform mechanical maintenance in a satisfactory and safe way, by virtue of theoretical preparation and proven experience.

In general, those using the lifting device must have the following characteristics:

- Use of the lower and upper limbs
- Knowledge and recognition of colors, good vision and good hearing Knowledge of warning and warning signs Master the operation of the lifting device.

1.5 INTENDED USE OF THE LIFTING DEVICE

1.5.1 DESTINATION

The lifting device has been specially designed for the axial lifting of the cable drums, according to the European directive 2006/42/EC.

The equipment is intended for use on construction sites, its operation will be entrusted to specialized and appropriately trained personnel, in accordance with the instructions contained in this user manual.

1.5.2 USERs OPERATORS OF LIFTING DEVICE

This lifting device is intended for professional use, and as such, assumes that it is operated by appropriately trained operators, especially as regards the safety of persons. Four types of operator are identified to be used for the operation and maintenance of the equipment:



LIFTING AND HANDLING VEHICLE OPERATOR

Operator authorized to use equipment for lifting and handling materials and machines, in compliance with the laws in force in the country where the equipment is used.



SECOND LEVEL CONDUCTOR

Personnel able to carry out the tasks of the first level operator and to operate with the lifting machine with a maintained action (JOG), to carry out simple operations to start production or restore it following a stop or regulation.



MECHANICAL MAINTAINER

Qualified technician able to drive the lifting machine in normal conditions, to operate it with a maintained action command (JOG), even with deactivated protections, to intervene on the mechanical parts to make the necessary adjustments, maintenance and repairs. It is not authorized to intervene on electrical systems in the presence of voltage.



MANUFACTURER TECHNICIAN

Qualified technician made available by the manufacturer, who carries out operations of a complex nature in particular situations. Depending on the case, it has mechanical, electrical, electronic or software skills.

VOLTA MACCHINE SRL Via Copernico, 13 A 39100 Bolzano - ITALIA	DEVICE FOR AXIAL LIFTING OF DRUMS MODELS: M46300000 M46400000	 FYN S KRAN UDSTYR A/S
--	--	--

1.5.3 EXPECTED REGULATIONS

This lifting device has been produced in a state belonging to the European Community, therefore it meets the safety requirements required by the following standards:

- Machinery Directive (Directive 2006/42 / EC)
- EN ISO 12100 (Safety of machinery - Fundamental concepts, general principles of design) This conformity is certified and the CE marking is present on the lifting device.

1.5.4 INTENDED USES AND NOT ALLOWED USES

The intended use of the lifting device is the axial lifting of the cable drums.

▲ ATTENTION

For any use other than that foreseen therefore, **VOLTA MACCHINE SRL** is not obliged to answer for any defects or risks deriving from the use of the lifting device.

1.5.5 PREVENTIVE MEASURES TO BE USED BY THE USER

- a)** Scrupulously observe the accident prevention regulations in force in the respective countries **b)** Observe all danger and caution indications.
- c)** Always use work gloves, safety shoes and anything else provided for by Legislative Decree 81/08.
- d)** The operator in charge of the installation and use of the lifting device must use clothing suitable for the work environment and the situation in which it is located; in particular, it must avoid the use of loose clothing, chains, bracelets, rings or anything else that can get caught.
- e)** The operator must not perform operations or interventions on his own initiative that are not within his competence.

1.5.6 CONDITIONS OF USE

ENVIRONMENTAL CONDITIONS

The hook does not require particular environmental conditions. It can be installed inside an illuminated and ventilated industrial building or outside, on a building site with a solid floor.

Environmental characteristics of the area in which the lifting device is used:

- Temperature from -10 ° C to + 45 ° C
- Relative humidity from 30% to 90% (± 5%)
- Any weather conditions

▲ ATTENTION

It is not intended for use in atmospheric conditions that can in any way inhibit the components of the lifting device.

DISPOSAL AND DEMOLITION

In the phase of putting out of service, for the demolition and disposal of the lifting device, or of every single part of the same, the user purchaser will have to follow the rules and regulations in force in his own state..

NOTE

There are no particular problems, since all the components used are recyclable.

By refusal is meant any substance and object deriving from human activities or from natural cycles, abandoned or destined to abandonment.

Special waste:

- those deriving from industrial, commercial, handicraft, agricultural and service activities whose quality or quantity are not classified as urban waste
- deteriorated and obsolete machinery and equipment

VOLTA MACCHINE SRL Via Copernico, 13 A 39100 Bolzano - ITALIA	DEVICE FOR AXIAL LIFTING OF DRUMS MODELS: M46300000 M46400000	 FYNs KRAN UDSTYR A/S
--	--	---

Harmful toxic waste:

- all waste that contains or is contaminated with the substances indicated in Directive 94/904 / EC.

NOTE

For the disposal of hazardous and special toxic waste, it is essential to contact specialized / authorized companies.

2. SAFETY NORMS

2.1 GENERAL WARNINGS

- The equipment may only be used by qualified personnel, as a LIFTING AND HANDLING MANUFACTURER, who is fully aware of the contents of this manual.
- The equipment may under no circumstances be used for other purposes than those for which it was designed (see section 2.3 - reasonably foreseeable misuse).
- The personnel assigned to the use of the equipment must wear the appropriate personal protection devices (PPE).
- The equipment is designed for use on construction sites.

2.2 ESSENTIAL SAFETY REQUIREMENTS

The equipment has been designed in compliance with the essential requirements of the Directive 2006/42 / EC, Annex 1.

For lifting, use only devices that comply with the 2006/42 / EC directive with a safety factor greater than 5. The end user will choose the suitable vehicle available on site.

NOTE

Compliance with the essential requirements means installation of the equipment carried out in a workmanlike manner, following all the provisions contained in these instructions for use.

⚠ ATTENTION

If the equipment shows any defect it should not be used: contact the technical assistance service.

Always check the integrity of the equipment in every single part.

Before approaching the equipment, remove from your person any hanging accessory (eg. necklaces, bracelets, loose cuffs, etc.) and collect long hair, as they could be dragged by the mechanisms.

Always wear personal protective equipment (PPE) when using the equipment. Every type of maintenance, adjustment or intervention must be carried out by qualified personnel (mechanical maintenance technician). It is recommended not to leave the equipment unattended or in any case to take all measures to prevent unauthorized operators from accessing it. Always use original specific parts for the model.

Any intervention on the equipment that modifies its functionality, with additions or removal of some parts, is forbidden.

Before operating the equipment, limit the work area with signs of non-access, or other similar and visible signs.

It is forbidden to proceed with lifting operations without making sure that the cable reel is in perfect conditions of use and conservation through inspection of visual defects for cracks, breakages, untying, deterioration of wood materials with respect to the original characteristics, etc .. (see also chapter 2.7 and chapter 5.3)

2.2.1 VIBRATIONS

In conditions of use that comply with the instructions for correct use, the vibrations are not such as to create dangerous situations; however, the use of anti-vibration gloves is recommended.

VOLTA MACCHINE SRL Via Copernico, 13 A 39100 Bolzano - ITALIA	DEVICE FOR AXIAL LIFTING OF DRUMS MODELS: M46300000 M46400000	 FYNYS KRAN UDSTYR A/S
--	--	--

2.2.2 SOUND EMISSIONS

The A-level equivalent sound pressure level and the B-level instantaneous sound pressure in workplaces is not likely to generate danger to operators.

2.2.3 ILLUMINATION

The lighting of the installation room must be in compliance with EN 12464-1-2 and ensure good visibility at every point, must not generate dangerous reflections and must allow the correct reading of the control panels, as well as the identification of the buttons of emergency of the lifting machine. Since the hook has no independent light sources, the aforementioned lighting of the room must be such as to guarantee, at any point, values between 200 and 300 lux.

2.3 USE INCORRECTLY FORESEEABLE REASON

- The following uses are to be considered foreseeable but NOT admissible by the manufacturer:
- loss of control of the equipment by the operator;
- conditioned reflexes of the user in case of malfunction, accident;
- loss of operator concentration;
- incorrect behaviour due to the choice of a more convenient way to carry out work on the equipment;
- closeness or contact with the equipment by persons unrelated to its use, the disabled or children.

In particular it is **NOT** allowed:

- use the equipment with not suitable lifting equipment
- use the equipment in areas where there is a risk of explosion
- use the equipment near cliffs, low ground or sloping terrain
- use the equipment without the protection devices installed and without having verified the good condition of the same.
- in the presence of corrosive and/or abrasive vapors, fumes or powders
- in the presence of flames and/or heat exceeding the permitted temperatures
- in areas where there are strong electromagnetic fields that can generate accumulations of electrostatic charges.

DANGER

The manufacturer declines all responsibility deriving from an improper use that can cause accidents to people and possible equipment malfunctions.

2.4 RESIDUAL RISKS

- Although all the protection measures aimed at risk reduction have been adopted during the design phase, the use of the equipment exposes the operator to the following residual risks:
- Risk of entanglement and crushing.
- Risk of falling material from above
- Rolling risk.

2.5 SIGNALING HAZARDS AND BANS

Near the area where the hook is used, the following safety signs are placed.



Generic danger.



Impact hazard due to impact, load swing. The indicated flow rates assume that the lifting device is stressed without shocks. Light shocks such as those caused by normal lifting and lowering, as well as by translation of the load with the crane are allowed. No strong shocks (eg bumping with the load during transport) or swinging of the load are permitted.



Do not tamper with safety devices and guards. Risk of crushing and dragging the limbs in the event that the equipment is used without its safety devices and its guards.



No transit under suspended loads. Avoid lifting or carrying loads in the presence of people in the operating area.
Keep a minimum distance of 5 m from the equipment.



It is forbidden to transport people on the lifting hook.

2.6 INDIVIDUAL PROTECTIONS (PPE)

For handling, installation, use, maintenance, cleaning and dismantling of equipment, the personal protective equipment (PPE) must always be worn, designed and manufactured in compliance with the EU 2016/425 regulation, in compliance with the regulations in force in the country of destination and individual establishment regulations. Apply the following signs to the area where the lifting device is used.



Protect the body.



Use safety footwear.



Use protective gloves of adequate thickness. The



use of a protective helmet is mandatory.

NOTE

Personal protective equipment (PPE) must be considered essential health and safety requirements (see section "2.2 Essential safety requirements").

2.7 CONTROLS AND CHECKS

- Before using the equipment, check its integrity and the absence of defects. Worn or defective parts will be replaced promptly. The checks must be carried out by an expert and must be both visual and functional.
- The main checks to be carried out on the hook can be summarized as follows:
- verification of the supporting structures (eg eyelet, feet), which must not show any cracks, breakage, damage, deformation, corrosion, wear or alteration with respect to the original characteristics
- verification of all mechanical parts
- verification of all connections with pins and screws
- checking the status of the hook; ovalizations of the holes, wear of the threads, seizure of the shackles, seizing of the bearings, problems on the welds.

VOLTA MACCHINE SRL Via Copernico, 13 A 39100 Bolzano - ITALIA	DEVICE FOR AXIAL LIFTING OF DRUMS MODELS: M46300000 M46400000	 FYNS KRAN UDSTYR A/S
--	--	---

WARNING

Before using the lifting hook, check the integrity and the absence of faults in the lifting cable reel.

The main checks to be carried out on the reel can be summarized as follows:

- check the bulkhead of the coil, which must not show any cracks, breakage, damage, deformation, wear or alteration with respect to the original characteristics;
- verification of all connections with pins and screws in the bulkheads; • verification of the state of conservation of the wood of the parts of the drum.

In case of anomalies, these must be eliminated before using the equipment.

In case of detection of cracks or dangerous anomalies it is necessary to promptly inform the manufacturer.

The equipment will be taken out of service until it has been completely repaired.

The qualified technician who performs the repair must write down on the appropriate card the repair done (see fac-similar to page 21 Maintenance card).

DANGEROUS

It is forbidden to tamper with the equipment in any of its components and / or parts.

It is forbidden to modify the equipment or change the intended use described in this manual without the written authorization of the Manufacturer.

3. TECHNICAL DESCRIPTION OF THE LIFTING DEVICE

3.1 CHARACTERISTICS

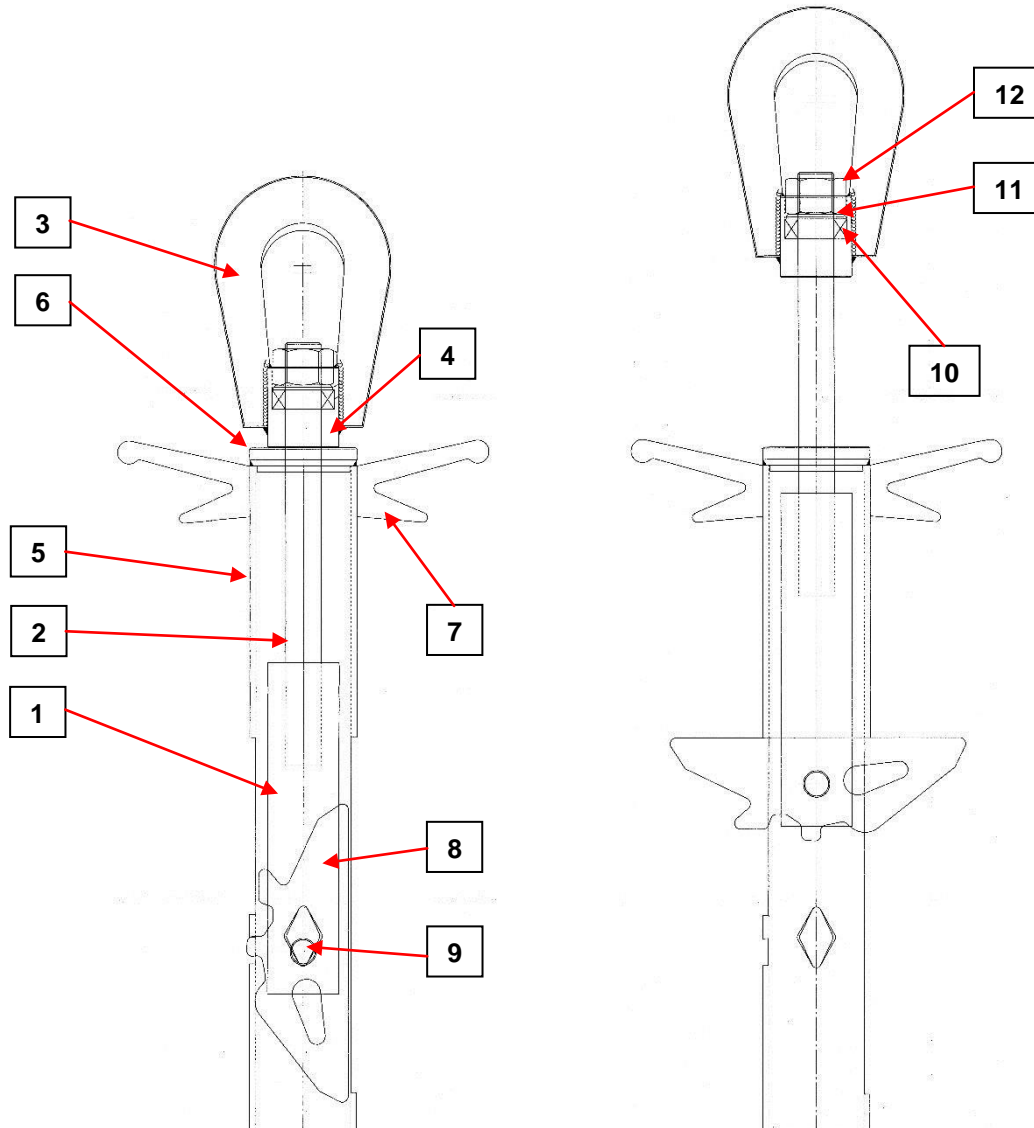

POS.	DESCRIPTION	POS.	DESCRIPTION
1	Fixing plates of the lifting device	7	Handles for transport/stop devices
2	Main support pin	8	Lifting throttle device
3	Upper ring made of sheet metal	9	Round pin
4	Lower eye ring - round hub	10	Thrust bearing
5	External cylinder	11	Washer
6	Cylinder closing ring	12	Nut

VOLTA MACCHINE SRL Via Copernico, 13 A 39100 Bolzano - ITALIA	DEVICE FOR AXIAL LIFTING OF DRUMS MODELS: M46300000 M46400000	 FYNS KRAN UDSTYR A/S
--	--	---

3.2 TECHNICAL DATA

MODEL CODE	LIFTING CAPACITY Kg	DRUM HOLE MIN./MAX. mm	WEIGHT Kg
M46300000	2000	60/140	8.5
M46400000	5000	90/160	18

4. INSTRUCTIONS FOR TRANSPORTING AND INSTALLING THE LIFTING DEVICE

4.1 HANDLING

WARNING



It is necessary to make sure that an appropriate electrical grounding measure has been provided at the construction site level

During unpacking and installation operations, always wear gloves and all suitable safety clothing (UNI EN 510 standards)

Upon receipt of the lifting device, make sure that the packaging has not been damaged during transport and that it has not been tampered with, with consequent possible removal of parts contained inside. Proceed with unpacking, making sure that the supply matches the order specifications.

In the event that damage or missing parts are found, notify immediately to **VOLTA MACCHINE SRL** and to the carrier presenting photographic documentation.

Important: after verification, if necessary, reserve on the delivery note, have it countersigned by the carrier and notify, if possible by fax, **VOLTA MACCHINE SRL**.

4.1.1 STORAGE

- In the case of a long inactivity of the lifting device, the customer must ascertain the environment in which it was placed and, in relation to the type of storage (box, floor, etc.), check the maintenance condition if possible.
- If the lifting and storage device is not used, it is advisable to follow the technical specifications.

VOLTA MACCHINE SRL Via Copernico, 13 A 39100 Bolzano - ITALIA	DEVICE FOR AXIAL LIFTING OF DRUMS MODELS: M46300000 M46400000	 FYNIS KRAN UDSTYR A/S
--	--	--

4.2 INSTALLATION OF THE LIFTING DEVICE

⚠ WARNING



The following instructions are intended for a conductor of materials lifting and handling equipment, in compliance with the laws in force in the country where the equipment is used.



During the handling phases, the maneuvering area will be accessible only to authorized persons. Do not leave the not authorized personnel near the equipment; do not stand in the 5 m radius of action of the lifting area. Before carrying out any type of handling and installation operation, the appropriate personal protective equipment must be worn.

If the brightness is lower than required by current regulations, illuminate the work area.

NOTE

The personnel assigned the task of installing the equipment must read the following instructions in order to adopt all the appropriate technical and organizational measures to minimize the risks associated with installation in compliance with Directive 2009/104 / EC in the field of occupational safety. The installer personnel must also take into account any possible emergency situations that may arise during the installation, repair, maintenance, cleaning, dismantling, dismantling and work environment in which the equipment will be installed.

4.2.1 PRELIMINAR CHECKS

- Set up a maneuvering area suitable for the size of the equipment.
- Check the correct functioning of all safety systems.
- Check the protections and set up the signs on the installation site.
- Check that the equipment has not been damaged during assembly.
- •Check the free movement and free rotation of all moving parts.
- Before lifting by crane, all operators must remove their hands from the equipment and move away at least 5 m.

4.2.2 FINAL CHECKS

At the end of the installation and before lifting it is necessary to perform the following checks:

- make sure that there are no people working on or in the immediate vicinity of the equipment.
Move away at least 5 m away.
- make sure that there are no foreign objects resting on the appliance. • It is forbidden to unwind the coil cable during lifting.

4.2.3 CARDBOARD, P.P.E. AND TRAINING

BY THE PURCHASER

The lifting device must be integrated into the working layout of the appropriate supplementary sign **USE PROTECTIVE CLOTHING AND SAFETY DEVICES (GLOVES, SAFETY SHOES, etc.)**

In addition, the place where the lifting device is used must be integrated with the general signs, specific to the characteristics of the premises and workplaces:

HANDLING, HAZARD ZONE, HIGH VOLTAGE

CARDBOARD AND P.P.E.

It is recommended to affix additional plates and decals, indicating the basic safety instructions. A series of safety stickers with different shape and color are applied on the tool according to the type of message to be transmitted.



PROHIBITION SIGNAL

It is a safety sign that prohibits a behavior from which could be a danger to the safety of people (serious injury or fatal outcome).



DANGER SIGNAL It is a safety signal that warns of a danger to the safety of the person and the machine.



PRESCRIPTION SIGNALS

These are safety signs that prescribe certain behaviors.



OVERALL SIGNAL

Rectangular reflective rectangular sticker with white (or yellow) and red 45 ° inclined stripes.



ADHESIVE PLATES ON THE MACHINE

When handling the lifting device, there is a risk of crushing hands and feet. Always keep the recommended safety distance.



It is mandatory to refer to this manual for all operations related to safety, use, cleaning, maintenance, lubrication and correct disposal of the product.

TRAINING

It is mandatory for the purchaser user of the lifting device to have the appropriate instruction and the training of the operators involved in the use of the lifting device.



5. ISTRUCTIONS FOR THE USE

The purpose of this paragraph is to underline the safety condition for the operator and for anyone operating on the lifting device

Before using the lifting device it is mandatory to read carefully all the rules contained in this manual.

When using the lifting device the following warnings must be followed:

- Carefully read all the safety messages shown in the manual.
 - It is necessary to wear clothes and safety clothing suitable for the type of work (UNI EN 510 standard)
 - When an operator detects faults, especially those that compromise safety, he is required to inform the site manager.
- Do not modify parts of the lifting device for any reason (connections, holes, finishes, etc.).



⚠ WARNING

The responsibility for interventions of any kind not authorized in writing by VOLTA MACCHINE SRL falls on the person who performs it, since, in fact, it becomes a manufacturer.

Do not tamper with or modify any mechanical component without prior written authorization.



Any changes must be authorized by the manufacturer. If the lifting device is used outside its limits of use or in some way altering the characteristics that are the prerogative of VOLTA MACCHINE SRL, it declines all responsibility.

⚠ WARNING

Always use the utmost caution and prevent untrained persons from acting on or near the lifting device.

5.1 PRELIMINARY ACTIONS

Before using the lifting device:

- Check the weight of the coil and, depending on the capacity of the hook, use the appropriate device model. (see chapter 3.2)
- During the lifting action, segregate the entire working area in a radius of at least 5m.
- Wear the P.P.E.
- Check that the cables wound in the reel are locked in such a way as to prevent them from accidentally unwinding during lifting and moving.
- The stacking of the coils must take place with the axis of the bore of the bobbin always vertical in order to guarantee its stability.

5.2 EQUIPMENT FOR THE LIFTING

Use one of the following equipment in order to hook and lift the lifting device:



Web slings



Hooks



Ropes



Portable crane



Lifting hoists

5.3 USE OF THE LIFTING DEVICE

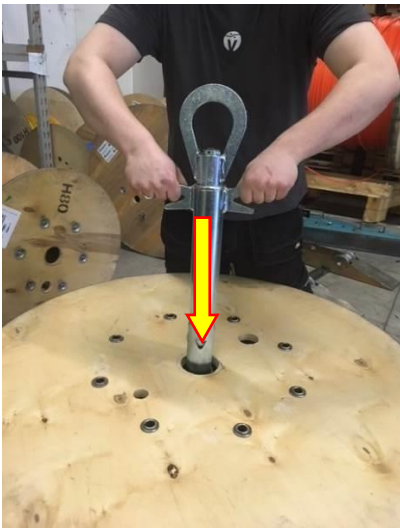

Photo 1



Photo 2



Photo 3

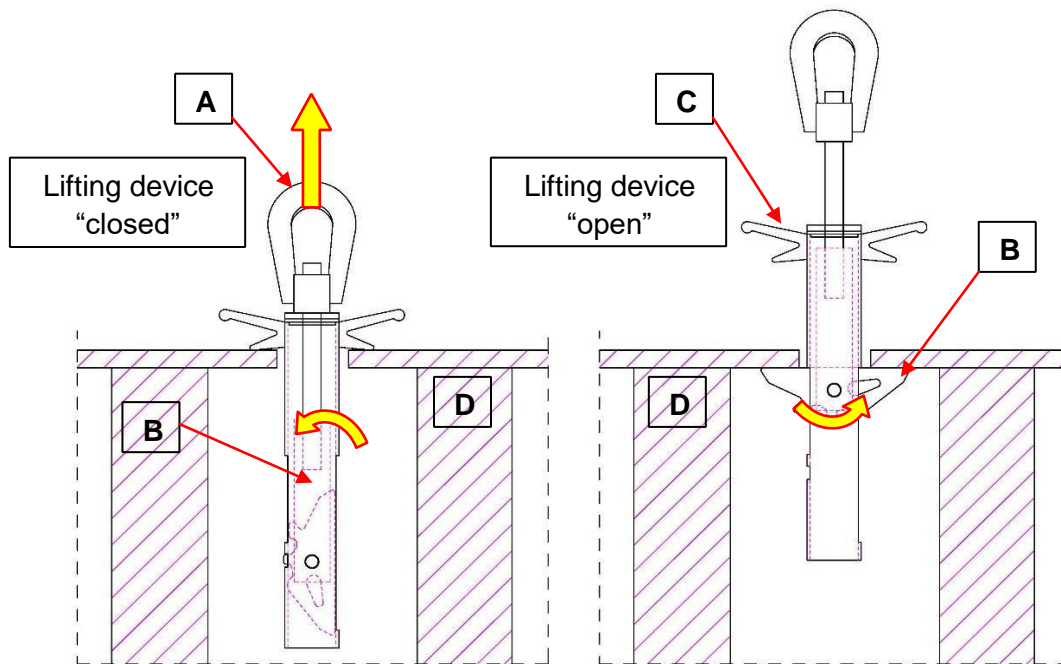

Insertion of the lifting hook in the drum hole

Lifting position

1. Insert the hook in the closed position in the bobbin hole (**Photo 1**) until it adheres to the bobbin surface (**Photo 2**).
2. Insert the crane hook (or any other lifting device, see **chapter 5.2**) into the eyelet **A** of the lifting device (**Photo 3**) to activate the hook opening mechanism **B**.
3. The bulkhead of the coil **D** rests on the legs **B** of the hook in the open position and is ready to be lifted.
4. Once the lifting operations have been completed, the hook of the crane must be unhooked and the handles **C** of the lifting device must be activated to release the support feet **B** and return the hook to the closed position.
5. Remove the lifting device.



6. MAINTENANCE



The maintenance must be performed by competent personnel:

- qualified mechanical maintenance technician:
a qualified technician able to drive the lifting device in normal conditions, to operate it with a maintained action control (JOG), even with deactivated protections, to intervene on the mechanical parts to carry out the necessary adjustments, maintenances and repairs. It is not authorized to intervene on electrical systems in the presence of voltage.
- manufacturer's technician: qualified technician, made available by the manufacturer, who carries out operations of a complex nature in particular situations. Depending on the case, it has mechanical, electrical, electronic or software skills.
Use accident-prevention clothing according to the UNI EN 510 standard

⚠ ATTENTION

Do not modify parts of the lifting device (connections, holes, finishes, etc.) for any reason: the responsibility of any type of intervention not authorized in writing **by VOLTA MACCHINE SRL** falls on the person who performs it, since, in fact, it becomes a manufacturer.

⚠ ATTENTION

Do not tamper with or modify any mechanical component without prior written authorization.

Any changes must be authorized by the manufacturer. If the lifting device is used outside its limits of use or in some way altering the characteristics that are the prerogative of **VOLTA MACCHINE SRL**, it declines all responsibility.

6.1 PERIODIC OPERATIONS

We recommend a visual check of the hook and the different components, checking the correct functioning of all moving parts before and after its use.

⚠ ATTENTION

VOLTA MACCHINE SRL declines all responsibility for damages to things and / or people caused by insufficient maintenance.

VOLTA MACCHINE SRL Via Copernico, 13 A 39100 Bolzano - ITALIA	DEVICE FOR AXIAL LIFTING OF DRUMS MODELS: M46300000 M46400000	 FYNS KRAN UDSTYR A/S
--	--	---

MAINTENANCE SHEET

Name of the user:

Address:

Ph. : **Fax :**

DATE OF PURCHASE	START-UP DATE
-------------------------	----------------------

--	--

IDENTIFICATION MARK	IDENTIFICATION Nbr.	YEAR OF MANUFACTURE
----------------------------	----------------------------	----------------------------

--	--	--

CONTROL

Date	Remarks	Sign